

basalte

Simplicity is the ultimate sophistication.

Leonardo da Vinci





The essence of home automation

Technology in the modern home is evolving more rapidly than ever, creating enormous possibilities. However, this can lead to systems that are complicated. Too complicated. We want to keep things simple, intuitive and elegant, both in its form and in its function. Reduced to its essence and improving the comfort of the modern home.

All Basalte products function in line with **KNX**, the global standard for home automation. Its open source structure allows hundreds of international manufacturers to develop KNX compatible products that function within the same system. This offers an unprecedented flexibility. It also offers the freedom of choosing from a wide product range and an international network of KNX certified installers.

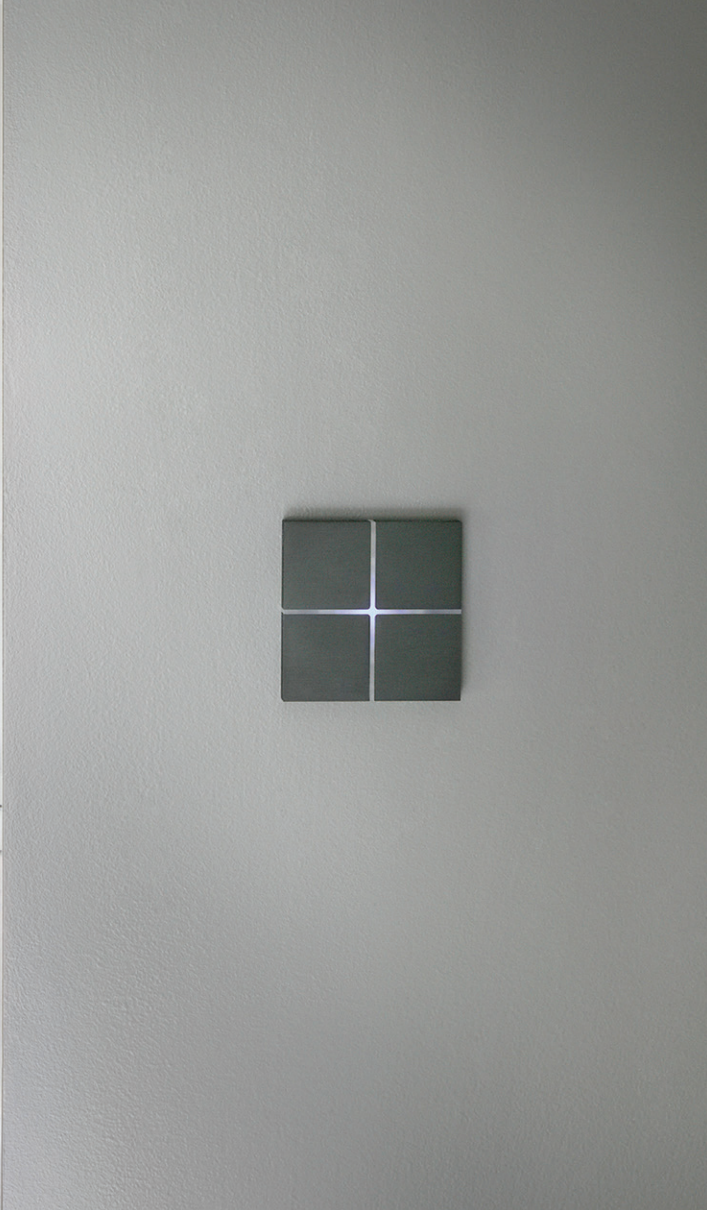

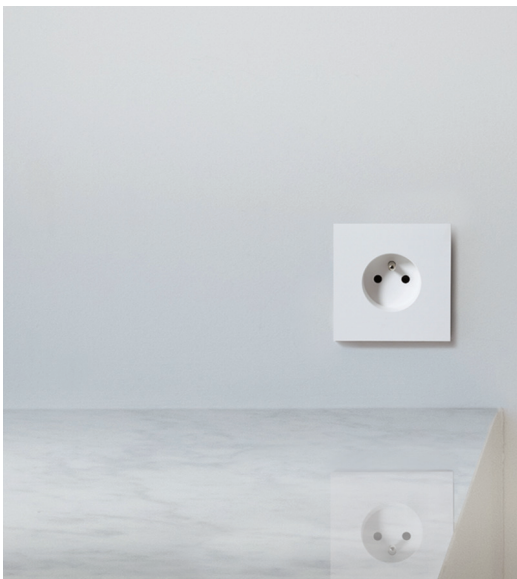

switches p8

intelligent thermostat p22

motion detector p28

sockets p34

frames p40

walkway light p42

flush mount p46

technical specifications p50

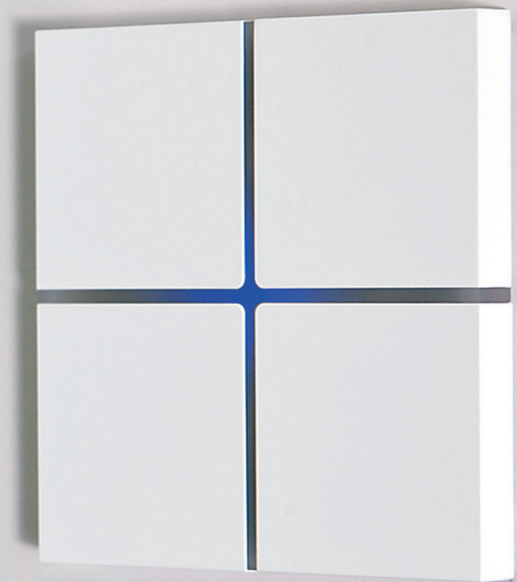



DESIGN PLUS
2008



reddot design award
winner 2008

sentido switch

Sentido is a touch-sensitive switch that is divided into two or four equal surfaces, each with its own functionalities. The entire surface of Sentido is touch-sensitive, creating an innovative and unique user experience. Lights, shades and scenes can be operated even at the slightest touch. Touching more than one surface at the same time, turns on and off all the lights in a room using a welcome and goodbye scene.

This multi-touch function makes light control highly intuitive and user-friendly. Holding multi-touch for a longer period starts the unique scene sequencer function, which allows selecting up to four additional scenes.

Sentido also has an internal temperature sensor, which discretely reports the temperature to the home automation system. The integrated thermostat logic controls the heating and air-conditioning of the room.

The multicolour LED backlight can be used for status feedback or simply to light up Sentido in the dark. In combination with multi-touch, the RGB sequencer controls RGB lights in a very simple and intuitive way.

Sentido's sleek and minimalist look and the use of high-grade materials results in a timeless design, which blends in every architectural environment.

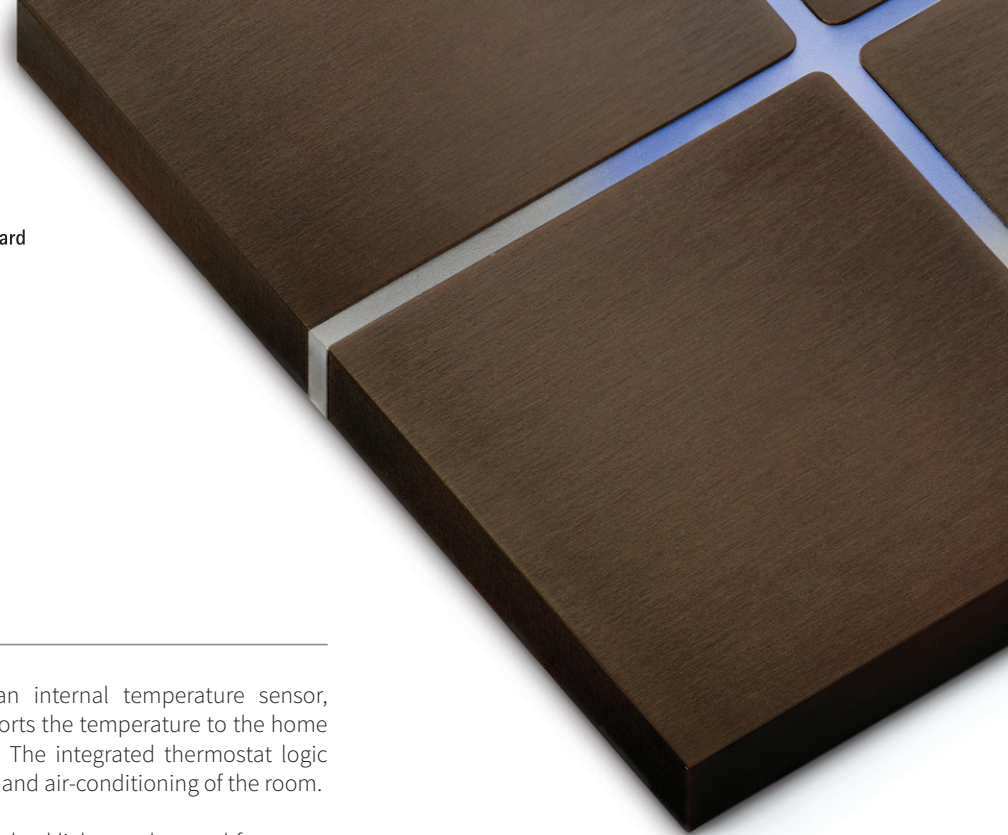

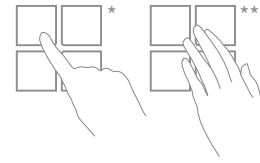
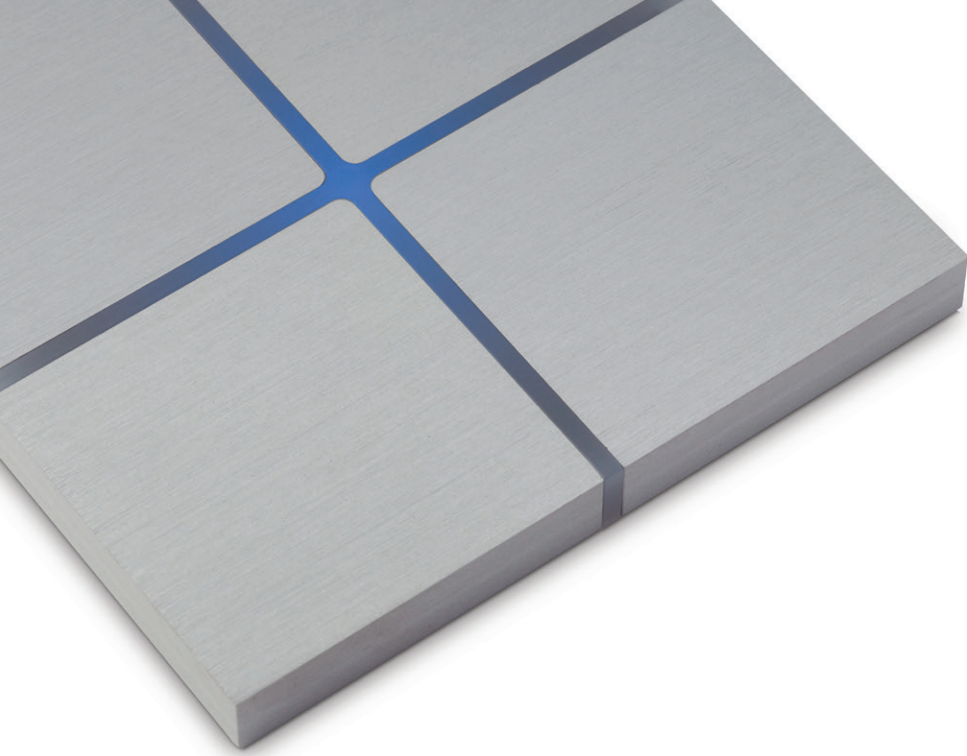

4-way

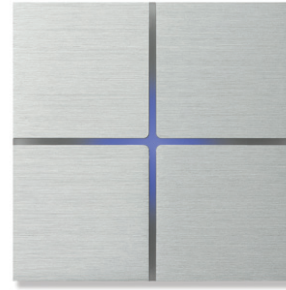

0202-01 brushed aluminium



0202-02 brushed dark grey

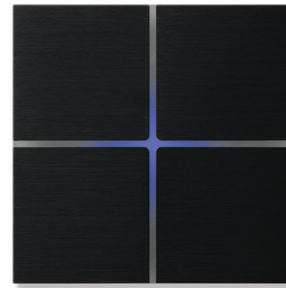

0202-03 brushed black



0202-04 satin white

sentido collection aluminium

Aluminium is a light, strong material. Its sleek look appeals to the most contemporary designers, while the black & white finish blend in any style. Pure Belgian-made quality, right at your fingertips.

2-way

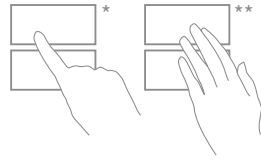

0201-01 brushed aluminium



0201-02 brushed dark grey



0201-03 brushed black

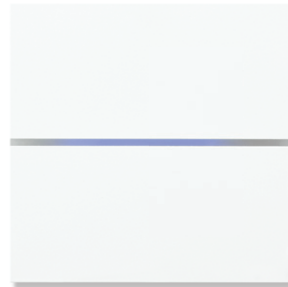

0201-04 satin white

- 4 single touch surfaces * or 2 single touch surfaces *
- 1 multi-touch functionality **
- integrated scene sequencer and RGB sequencer
- multicolour LED backlight
- temperature sensor with integrated thermostat logic
- dimensions: 80 mm x 80 mm x 8 mm
- combined with Sentido switch KNX (0200-02)

sentido collection

classic

Bronze, brass, nickel and copper are classics for a reason. Their well-known quality & beauty fit in a wide range of interior styles: the perfect finish for your historic home or the classic touch in your contemporary design. Handmade in Belgium.

- 4 single touch surfaces * or 2 single touch surfaces *
- 1 multi-touch functionality **
- integrated scene sequencer and RGB sequencer
- multicolour LED backlight
- temperature sensor with integrated thermostat logic
- dimensions: 80 mm x 80 mm x 8 mm
- combined with Sentido switch KNX (0200-02)

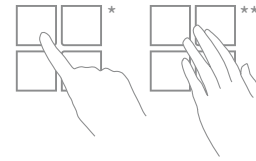

4-way

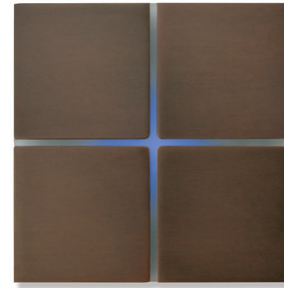

0202-05 bronze

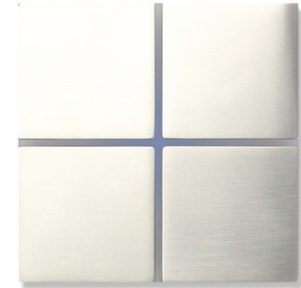

0202-07 brushed nickel

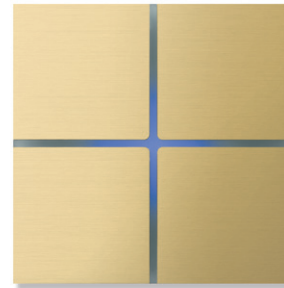

0202-08 brushed brass

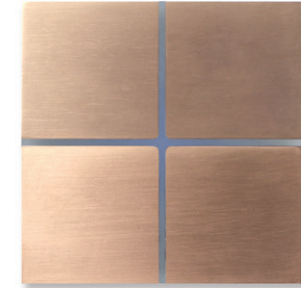

0202-20 soft copper

2-way

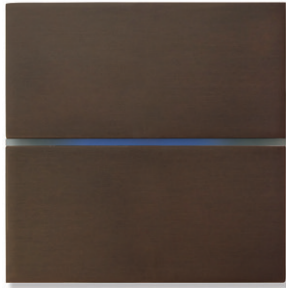
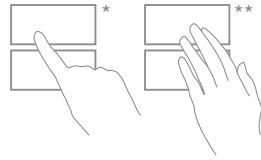

0201-05 bronze



0201-07 brushed nickel

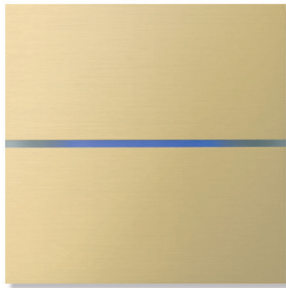

0201-08 brushed brass

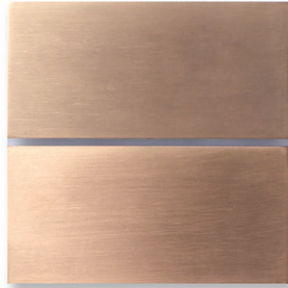

0201-20 soft copper

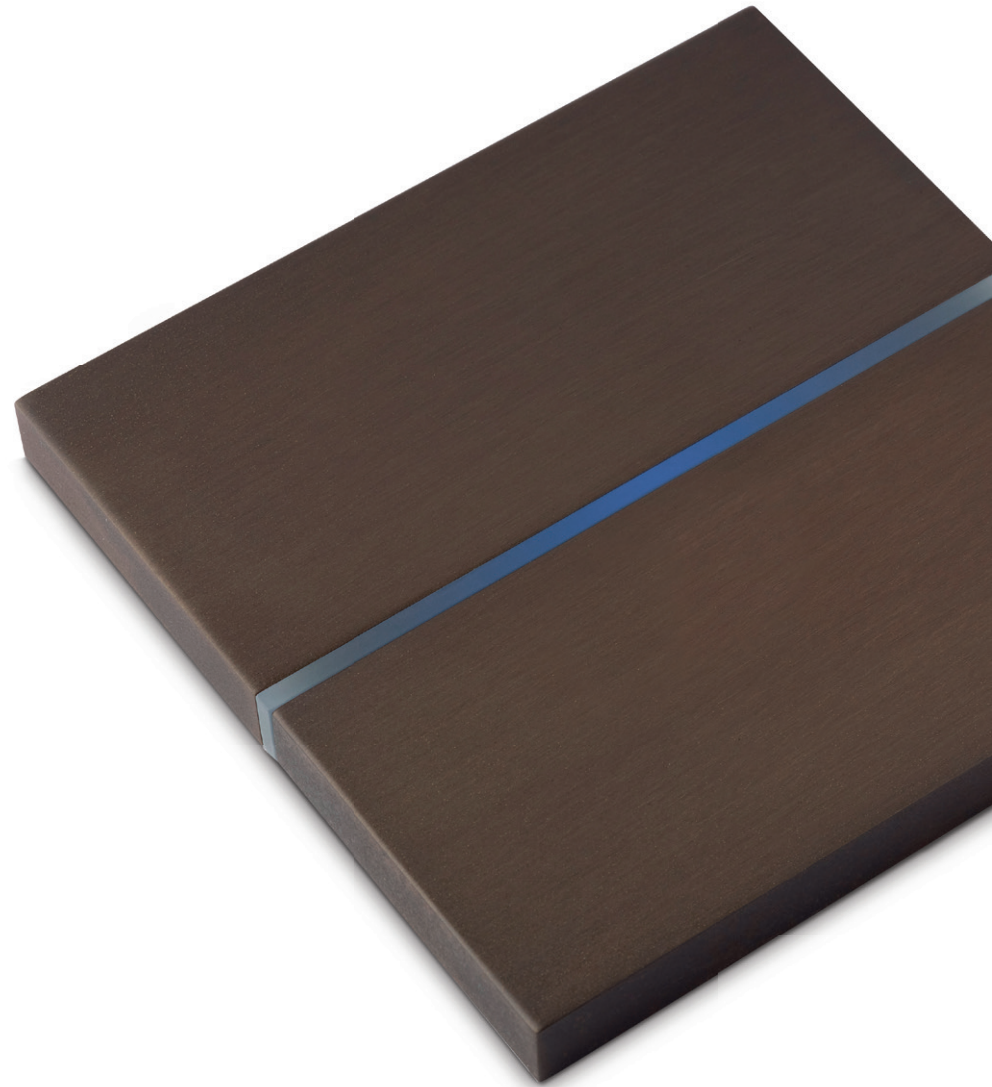



sentido collection

fer forgé

Perfection is in the details. Enjoy the authentic look of these hand textured covers, exclusively made in Belgium to the highest quality standards. Each cover is unique: a true design statement in your interior.

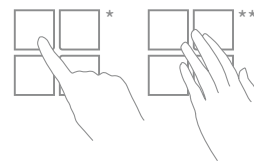

4-way



0202-06 fer forgé grey

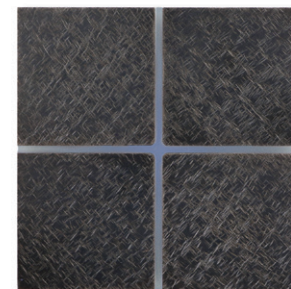

0202-17 fer forgé gunmetal

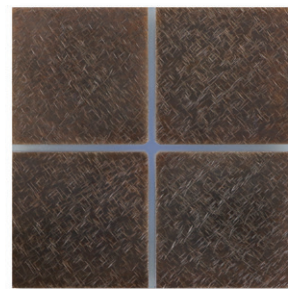

0202-18 fer forgé bronze

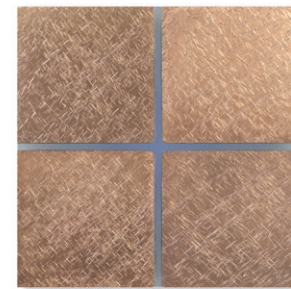

0202-19 fer forgé rosé

2-way

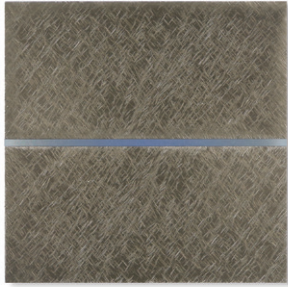
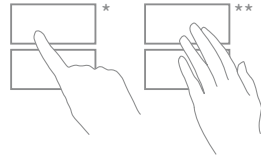

0201-06 fer forgé grey

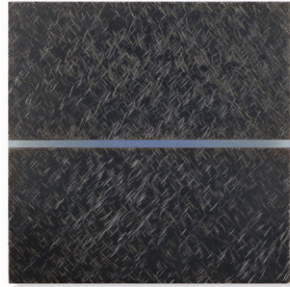

0201-17 fer forgé gunmetal

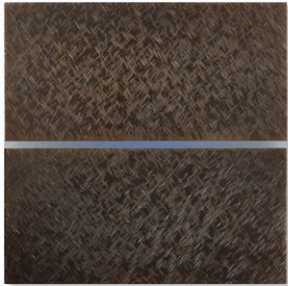

0201-18 fer forgé bronze

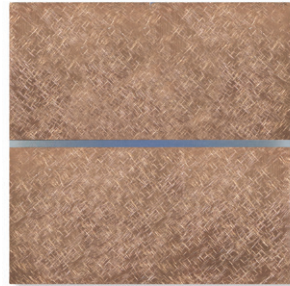

0201-19 fer forgé rosé

- 4 single touch surfaces * or 2 single touch surfaces *
- 1 multi-touch functionality **
- integrated scene sequencer and RGB sequencer
- multicolour LED backlight
- temperature sensor with integrated thermostat logic
- dimensions: 80 mm x 80 mm x 8 mm
- combined with Sentido switch KNX (0200-02)



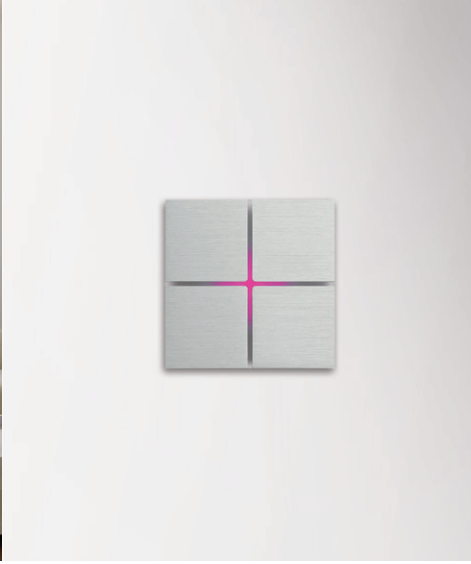





best of
DESIGN PLUS
2010



reddot design award
winner 2010

enzo switch

Inspired by Italian design of the late fifties, Enzo combines retro with luxury based on craftsmanship and high-quality materials.

The fine rounded border is made of polished aluminium while the inlay can be leather or glass.

Despite its retro look, Enzo uses the latest technology and features highly sensitive touch sensors, multi-touch capability and temperature control.

Enzo offers the same unique and innovative functionalities as Sentido.

The integrated multicolour LED backlight makes Enzo visible in the dark and can also be used for status feedback.

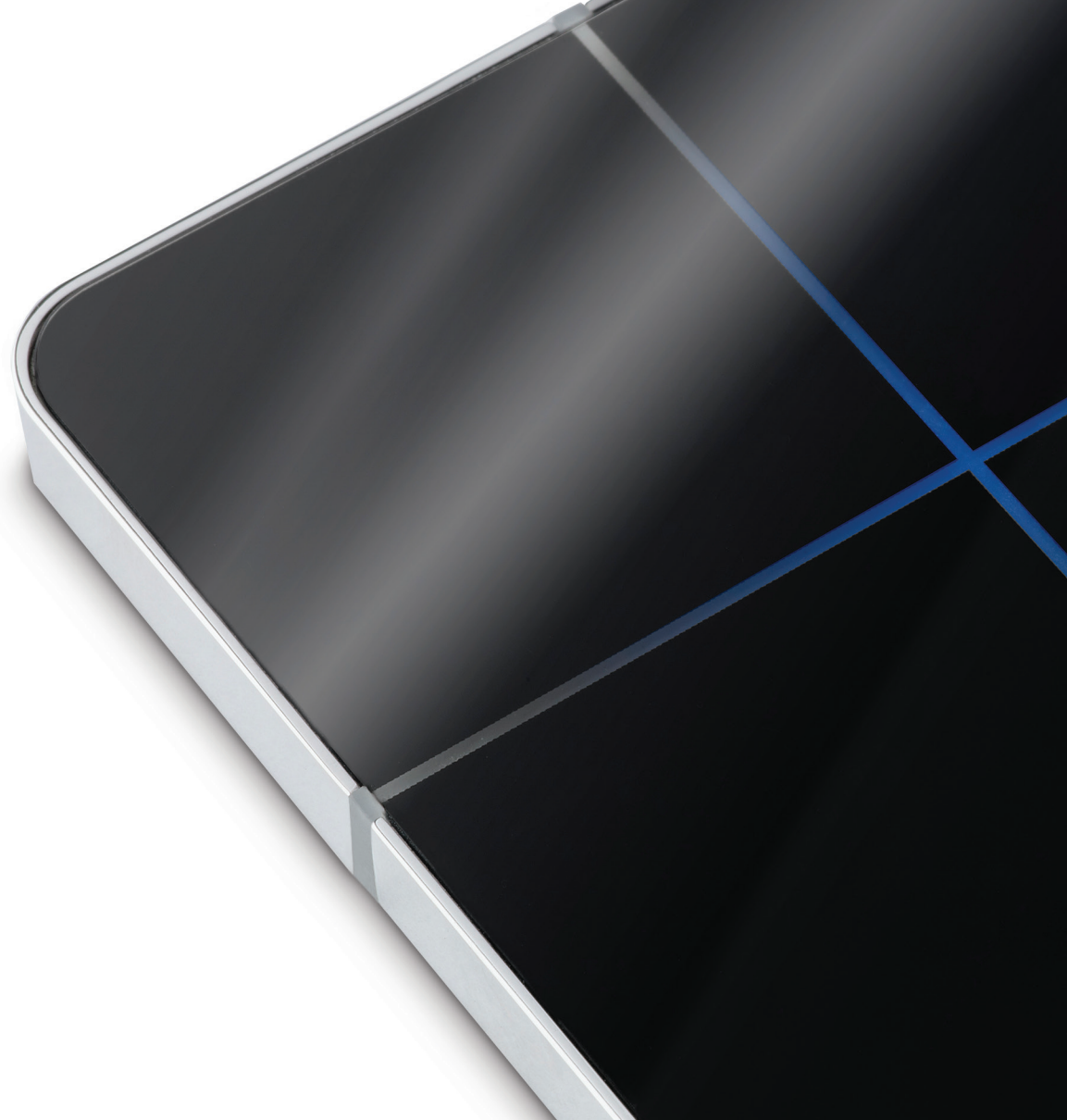



enzo collection

The Enzo finishes distinguish themselves as the retro alternative for black or white, introducing rounded edges with a high-quality inlay of leather or glass. The finishing touch to your interior never looked this good before.

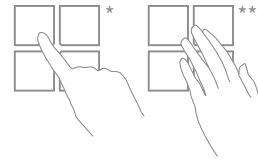

4-way

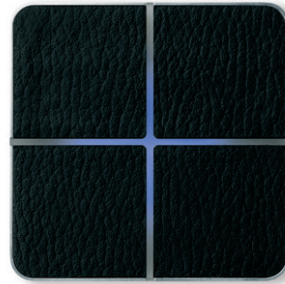

0204-13 black leather



0204-14 white leather

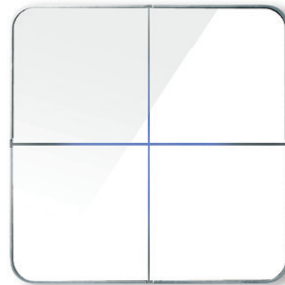

0204-04 white glass



0204-03 black glass

2-way

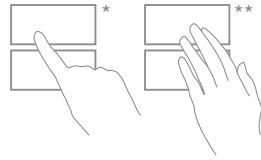

0203-13 black leather



0203-14 white leather



0203-04 white glass



0203-03 black glass

- 4 single touch surfaces * or 2 single touch surfaces *
- 1 multi-touch functionality **
- integrated scene sequencer and RGB sequencer
- multicolour LED backlight
- temperature sensor with integrated thermostat logic
- dimensions: 80 mm x 80 mm x 8 mm
- combined with Sentido switch KNX (0200-02)



bureau
24.0°C

DESIGN PLUS
2012

AWARD
Global Award for the very best
in Interior and Architecture 2012



German
Design Award
WINNER 2013



WINNER VAN DE VERGEE
LABELS 2011



product
design
award
2011



reddot design award
winner 2011

deseo

intelligent thermostat

At first glance, Deseo is a beautiful and intelligent thermostat, but Deseo is much more than that.

Deseo offers a simple and innovative user interface with touch-sensitive sensors that allow you to navigate through all functions in a room. Lights, scenes and shades, even the multiroom audio system can be controlled at the slightest touch.

This innovative concept allows light switches in a room to remain simple and only control the most important functionalities. All other, less frequently used functions can be controlled with Deseo.

Therefore, we call it a room controller.

The general menu displays the main functionalities in the room (lights, temperature, shades...) and the sub menu then shows all individual elements, ready to easily be controlled.

For smaller rooms, where only a few functionalities are integrated, Deseo also offers a simplified menu structure. Here, all individual elements are then displayed in one horizontal line, allowing the same fast and intuitive way of control.

As with Sentido, a simple multi-touch will start a welcome or goodbye scene. Thanks to the various elegant finishes in high-grade materials, Deseo easily blends in every interior.





aluminium

deseo collection

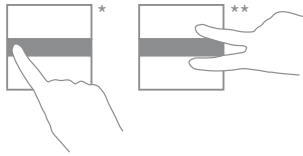

- touch controlled menu *
- 1 multi-touch functionality **
- 1.7" oled display
- temperature sensor with integrated thermostat logic
- dimensions: 80 mm x 80 mm x 8 mm
- combined with Deseo switch KNX (0300-02)



0301-01 brushed aluminium



0301-02 brushed dark grey



0301-03 brushed black

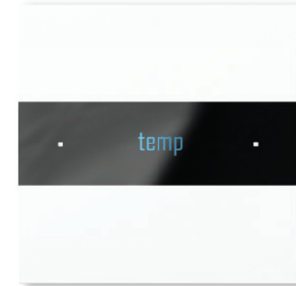

0301-04 satin white

classic



0301-05 bronze

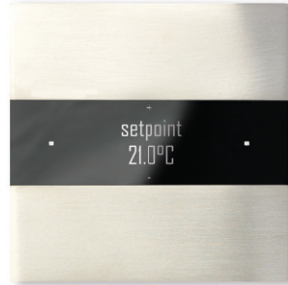

0301-07 brushed nickel



0301-08 brushed brass



0301-20 soft copper

fer forgé



0301-06 fer forgé grey



0301-17 fer forgé gunmetal



0301-18 fer forgé bronze



0301-19 fer forgé rosé

deseo retro collection

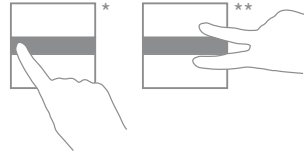

- touch controlled menu *
- 1 multi-touch functionality **
- 1.7" oled display
- temperature sensor with integrated thermostat logic
- dimensions: 80 mm x 80 mm x 8 mm
- combined with Deseo switch KNX (0300-02)



0301-13 black leather



0301-14 white leather



0301-24 white glass



0301-23 black glass





auro motion detector



Auro is everything a motion detector should be: small, fast and almost invisible. When mounted in the ceiling, the innovative flat design makes Auro completely blend in. Only requiring an opening of 43 mm, it is very easy to install.

Auro has a built-in light sensor for light dependent switching, dimming and controlling scenes and can even behave differently during day or night.

The internal temperature sensor discretely reports the room temperature to the home automation system while it can also be used to trigger a heat alarm in case of an abnormal temperature rise.

With a vertical detection angle of 90° it has a detection area with a diameter of 5 m when installed at a height of 2.5 m, making it perfect for hallways, toilets and small rooms.

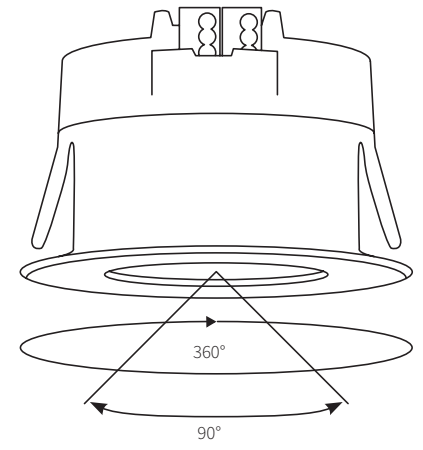
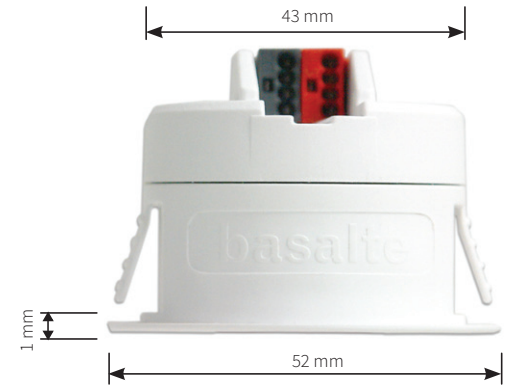

true size

auro collection

- completely flat design
- visible diameter 52 mm
- visible thickness 1 mm
- 360° range horizontal
- 90° range vertical
- integrated LED feedback
- integrated LED nightlight
- integrated day and night mode
- integrated temperature sensor
- available in white and black
- integrated lux sensor (only white version)



0180-02 white



0180-03 black

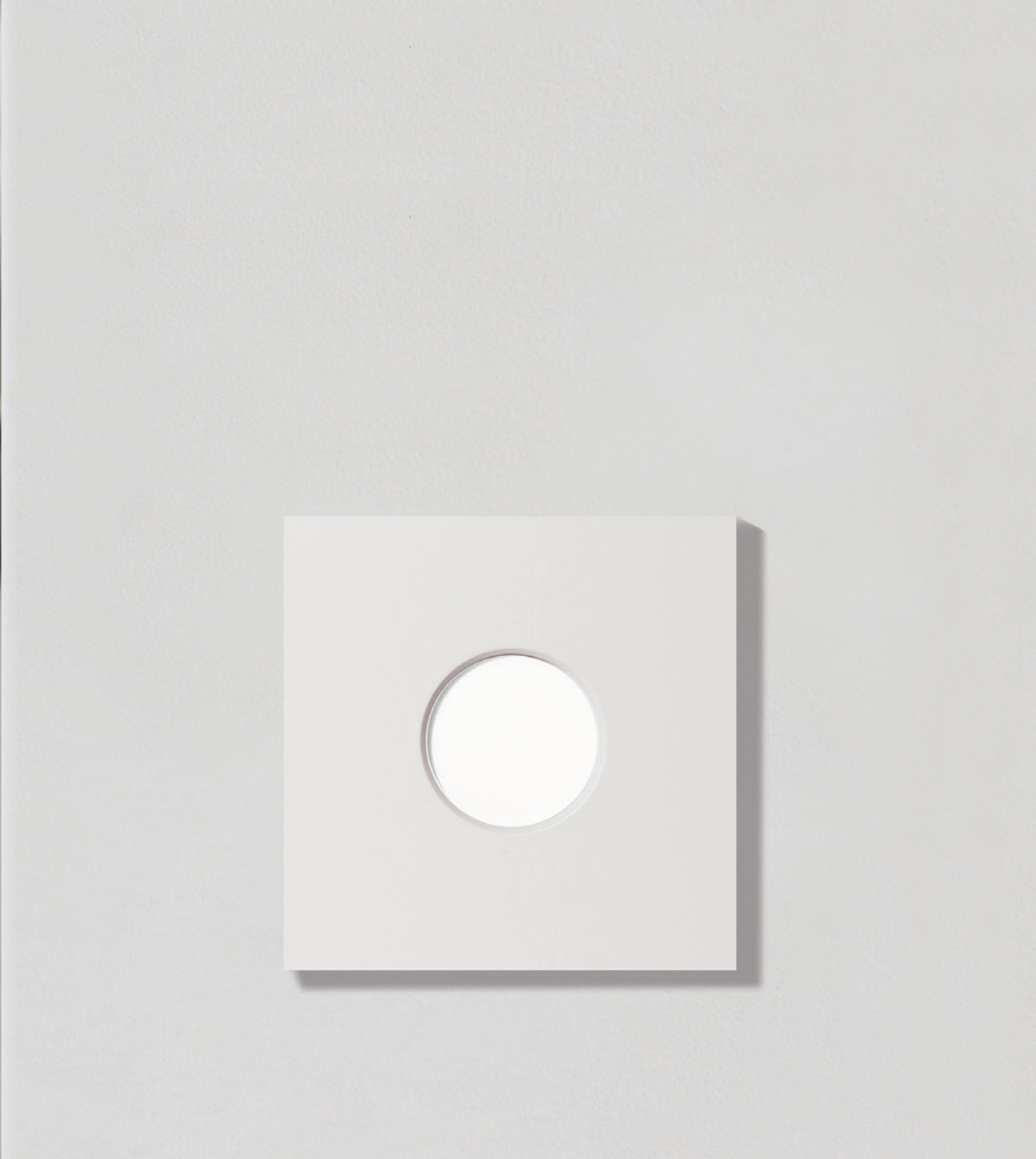

auro wall version

Auro is typically installed in ceilings, but there are also numerous applications where it is useful to have a motion detector in your wall: think near stairway cases where you have an open ceiling, in a hallway or next to the bed.

The optional wall cover lets Auro blend in, as it shares the same form factor and high-end finishes as our exclusive switches, thermostats and sockets.

For a full wall mounted solution, you combine the Auro motion sensor with an adapter and a cover from the aluminium, classic or fer forgé finish collection.



0181 - 91

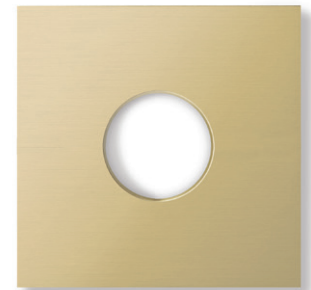
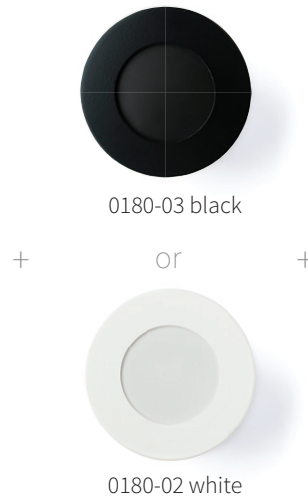

0181- colour code/finish



sockets

Our unique socket collection is available in the same dimensions and high-quality finishes as our design switches. A discrete solution that neatly integrates in any interior, thanks to its refined, uniform design.

The sockets are available in 1-2-3 gang versions, with earth pin (type E) or earthing clips (type F). The sockets can also host USB and RJ45 UTP.

A single gang version is available with a type E/F, USB or RJ45 UTP insert. The dual gang version hosts 1 type E/F insert to then freely combine with a type E/F, USB or RJ45 UTP insert. The triple gang version hosts 2 type E/F inserts to then freely combine with type E/F, USB or RJ45 UTP.

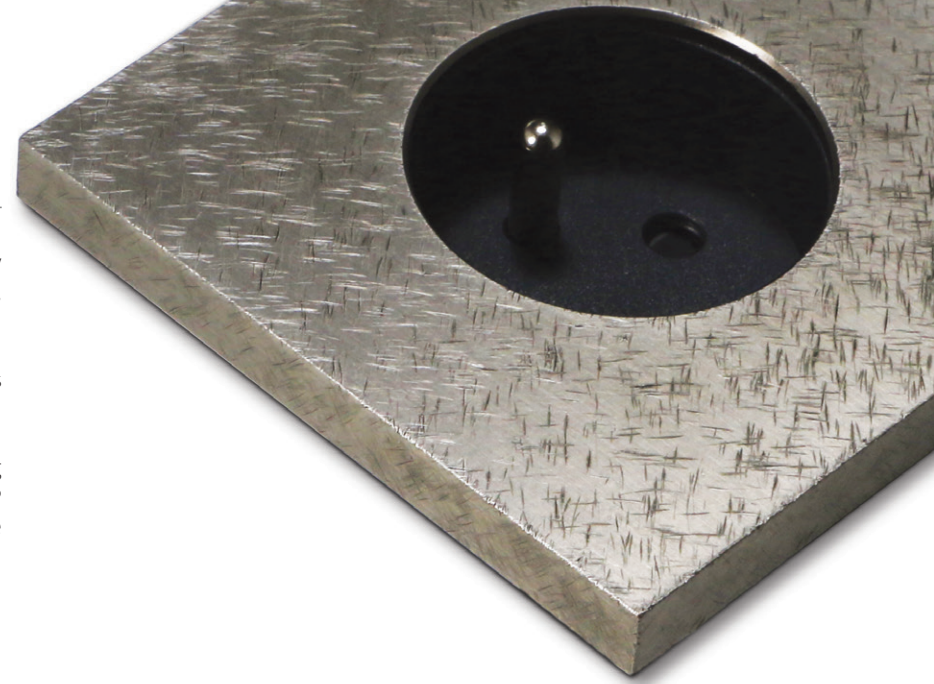

product codes

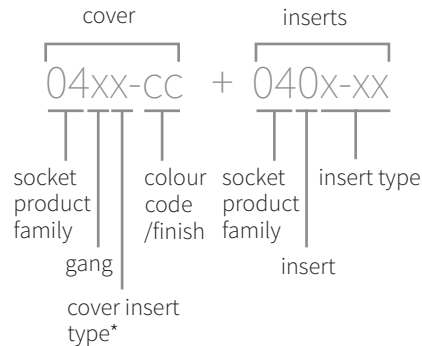

A complete socket is a combination of 1 cover and the required inserts. For a single gang version, you require 1 cover and 1 insert. For a 2-3 gang version, you require 1 cover and 2-3 inserts.

* codes cover insert type
 1 = cover insert type E or F
 2 = cover insert USB
 3 = cover insert RJ45 UTP

insert types to combine

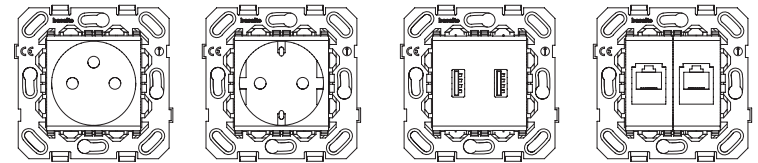

insert type E	insert type F	insert USB	insert RJ45 UTP
0401-03 black	0401-13 black	0402-03 black	0403-03 Cat5e
0401-04 white	0401-14 white	0402-04 white	0403-13 Cat6



1 gang collection _____



0411-01 + 0401-03



0412-20 + 0402-03



0413-18 + 0403-03



2 gang collection —



0421-04 + 2x 0401-04



0422-07 + 0401-13 + 0402-03



0423-17 + 0401-03 + 0403-03





3 gang collection _____



0431-03 + 3x 0401-03



0432-05 + 2x 0401-13 + 0402-03



0433-19 + 2x 0401-03 + 0403-03



frames _____

Our frames can be used in combination with 55 mm inserts from the manufacturers Schneider/Merten, Gira or Jung. The frames are available in 1, 2, 3, 4 and 5-gang, in the same finishes as our switches and sockets.

On demand, our frames are also available for Swiss socket inserts. These frames can be used in combination with 60 mm inserts from the manufacturers Feller, ABB or BKS.

- dimensions:

1-gang:	80 mm x 80 mm x 9 mm
2-gang:	151 mm x 80 mm x 9 mm
3-gang:	222 mm x 80 mm x 9 mm
4-gang:	293 mm x 80 mm x 9 mm
5-gang:	364 mm x 80 mm x 9 mm



001-CC*



002-CC*



003-CC*



004-CC*



005-CC*

*CC = colour code/finish





via walkway light —

The ultimate comfort is to conveniently control your home technology, but also to feel safe as you walk around the house, even when it's dark. For those moments, we developed the Via walkway light.

Typically installed at socket height, Via subtly illuminates the floor to help you navigate throughout the house. It has the same form factor and high-end finishes as the Basalte switches and sockets to beautifully blend in any interior.



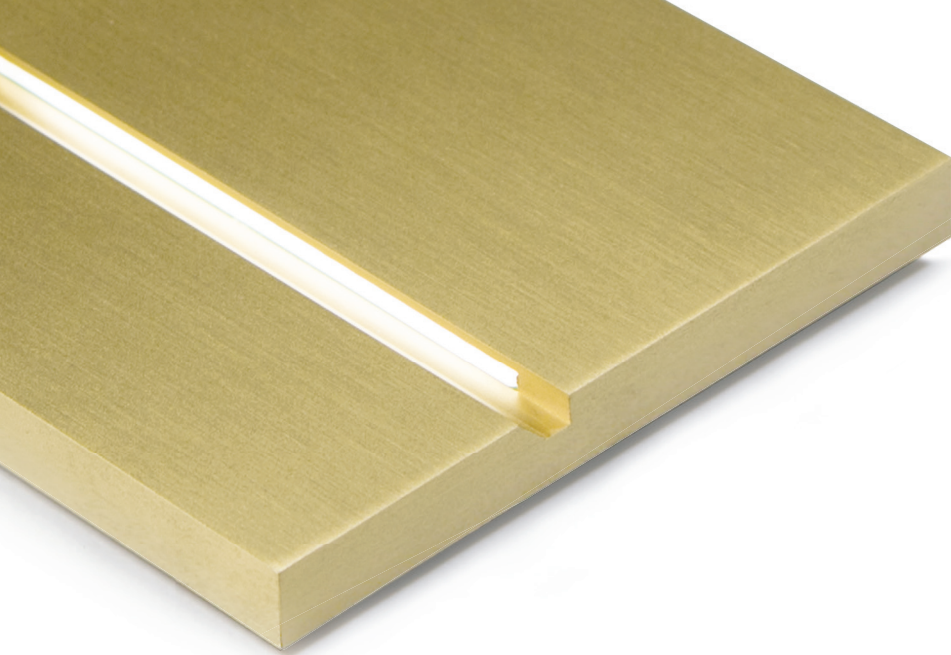

aluminium



0481-01 brushed aluminium



0481-02 brushed dark grey



0481-03 brushed black



0481-04 satin white

via collection

- dimensions: 80 mm x 80 mm x 8 mm
- combine with 24 V electronics (0480-01) or 220 V electronics (0480-11)

classic



0481-05 bronze



0481-07 brushed nickel



0481-08 brushed brass



0481-20 soft copper

fer forgé



0481-06 fer forgé grey



0481-17 fer forgé gunmetal

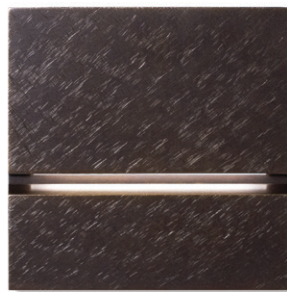

0481-18 fer forgé bronze



0481-19 fer forgé rosé



flush mount _____

In some projects, the interior designer aims for a sleek, minimalist design. To attend these needs, Basalte has a flush mount kit to integrate the switches* or 1 gang frames flush with the wall. The kit securely mounts the device and still allows easy access, insertion and removal.

* the mount is applicable for all Sentido and Deseo finishes.
Enzo, Deseo retro finishes and Basalte sockets are not compatible.

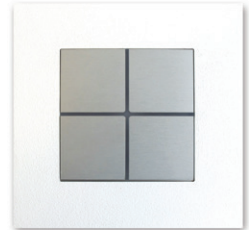
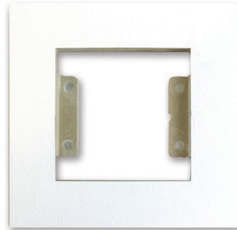
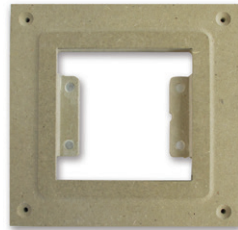





technical specifications

specifications may alter without prior notice

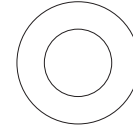
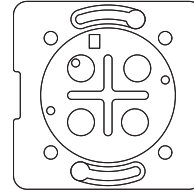
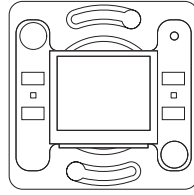

KNX

KNX

KNX

	deseo KNX / 300-02	sentido KNX / 0200-02	auro KNX / 0180-02/0180-03
name / product number	deseo KNX / 300-02	sentido KNX / 0200-02	auro KNX / 0180-02/0180-03
front cover	deseo	sentido and enzo	-
interface	KNX integrated BCU	KNX integrated BCU	KNX integrated BCU
display	1.7" Oled	-	-
multi-touch	yes	yes	-
scene- and RGB sequencer	-	yes	-
multicolour LED	-	integrated	white LED integrated
temperature sensor	integrated	integrated	integrated
thermostat logic	integrated	integrated	-
lux sensor	-	-	integrated (only 180-02)
power supply	15 - 30V DC separate from KNX bus	KNX buspower	KNX buspower
power consumption	1W	10mA	10mA
dimensions	70 mm x 70 mm x 30 mm	70 mm x 70 mm x 25 mm	diam: 52 mm x 39 mm
backbox	European standard box with screws 60 mm	European standard box with screws 60 mm	cutout diam: 43 mm
certification	CE	CE	CE

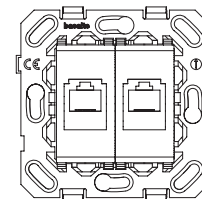
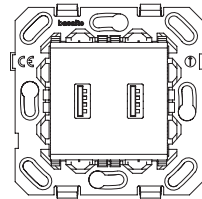
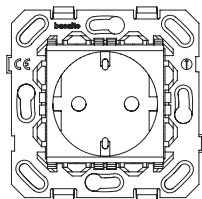
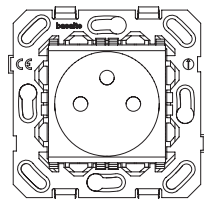

name	Power insert - type E	Power insert - type F	USB power supply 5 V 2,1 A	RJ45 UTP insert
insert number	0401-03 black 0401-04 white	0401-13 black 0401-14 white	0402-03 black 0402-04 white	0403-03 Cat5e 0403-13 Cat6
specifications	16 A 250 V AC 2P+E	2P+E 16 A 250 V AC	2 USB ports providing a total of 2,1 A; suitable to charge a 2,1 A single device or two 1 A devices simultaneously supply voltage 120-230 V~ 50/60 Hz	Cat5e, unshielded T568A/B universal wiring Cat6, shielded T568A/B universal wiring
wall box	see installation manual for compatible wall boxes	see installation manual for compatible wall boxes	see installation manual for compatible wall boxes	see installation manual for compatible wall boxes
certification	CE	CE	CE	CE



basalte

basalte bvba
hundelgemsesteenweg 1a
9820 merelbeke
belgium
t +32(0)9 385 78 38

www.basalte.be
info@basalte.be

© basalte 2017

v.7.0

basalte is a registered trademark of basalte bvba. Handmade in Belgium.

Pictures shown are indicative only. The actual finishes can have a different surface aspect.

Some project pictures are shown from: Architecten Anja Vissers, ClicHome, Harris Grant, Smarthouser.

www.basalte.be